

| | | | | | | | | | |
|---|-------------------|----------------------------------|-------------------|------|----------------------------------|-------------------|-------------------------------|-----------|--------------|
| 306, 209, 109, 305, 210, 110. | 307, 136, 236. | 401, 404, 405, 406, 402, 403. | 407, 409, 408. | 410, | 413, 411, 415, 414, 412, 416. | 417, 418, 419. | 420, 421, 422, | 423, 424, | 211, 111. |
| 1, 313, 123, 224, 124, 0, 223, 225, 125. | 335 | 401, | 402, | 403, | 404, 405, 407, 406, 408. | 409, | 410, 413, 411, 412, 421, 414, | 415, | |

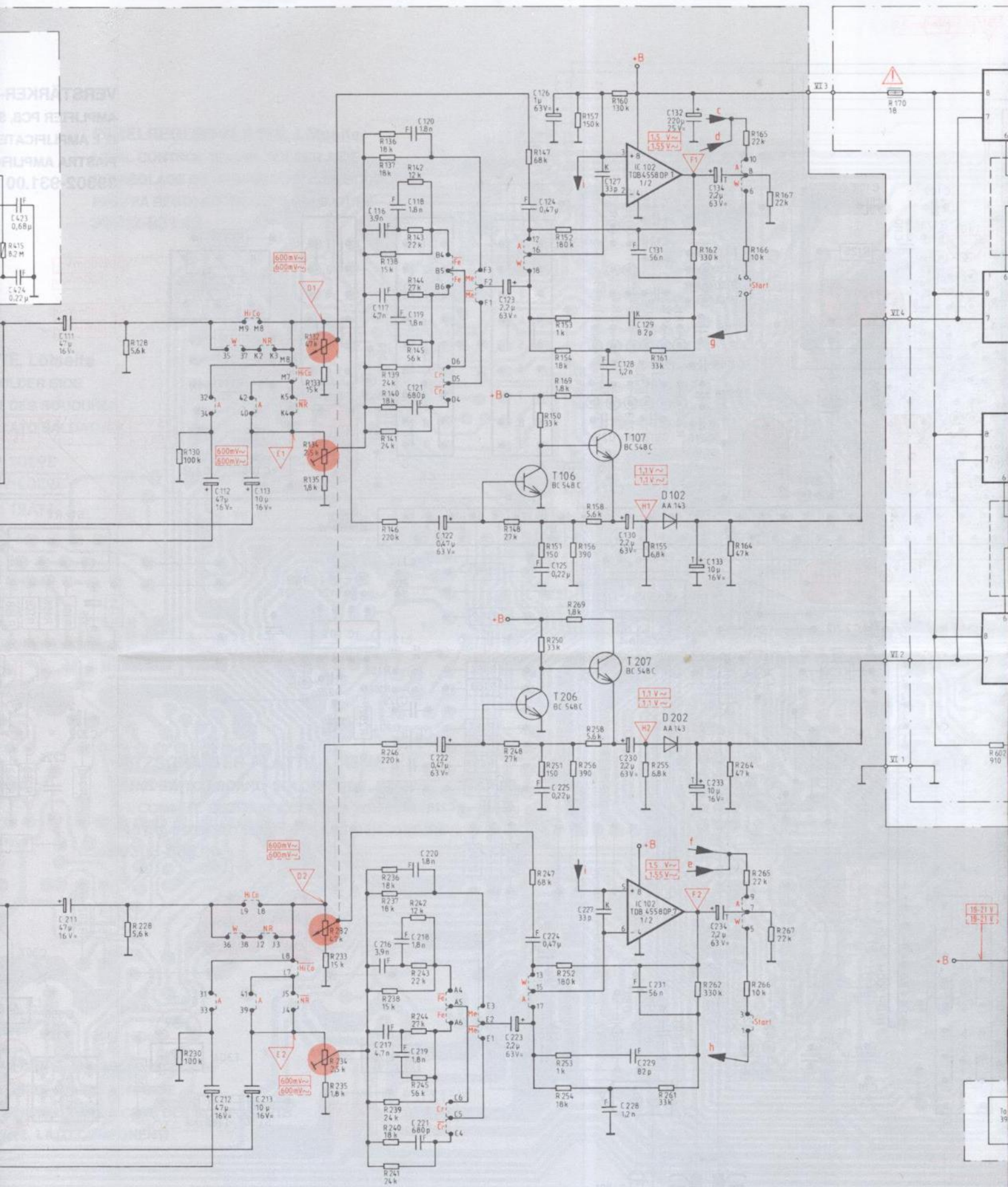

39102 - 931 00

| | | | | | | | |
|-----------|-----------|-----------|---|--|------------------------------------|---|---------------------|
| 423, 424. | 211, 111. | 212, 112. | 213, 113. | 116, 216, 120, 220, 218, 118, 122, 117, 217, 121, 219, 119, 222. | 123, 224, 225, 126, 223, 124, 125, | 128, 127, 230, 229, 231, 228, 227, 130, 129, 131, | 234, 233, 134, 133, |
| 415, | 128, | 230, | 266, 132, 232, 234, 134, 140, 139, 239, 241, 237, 245, 143, 242, 144, 148, 246, 133, 233, 235, 135, 137, 141, 240, 236, 136, 243, 145, 142, 244, 248, 147, 151, 150, 156, 269, 169, 254, 152, 155, 154, 162, 261, 164, 266, 166, 267, | 170 | 602 | | |

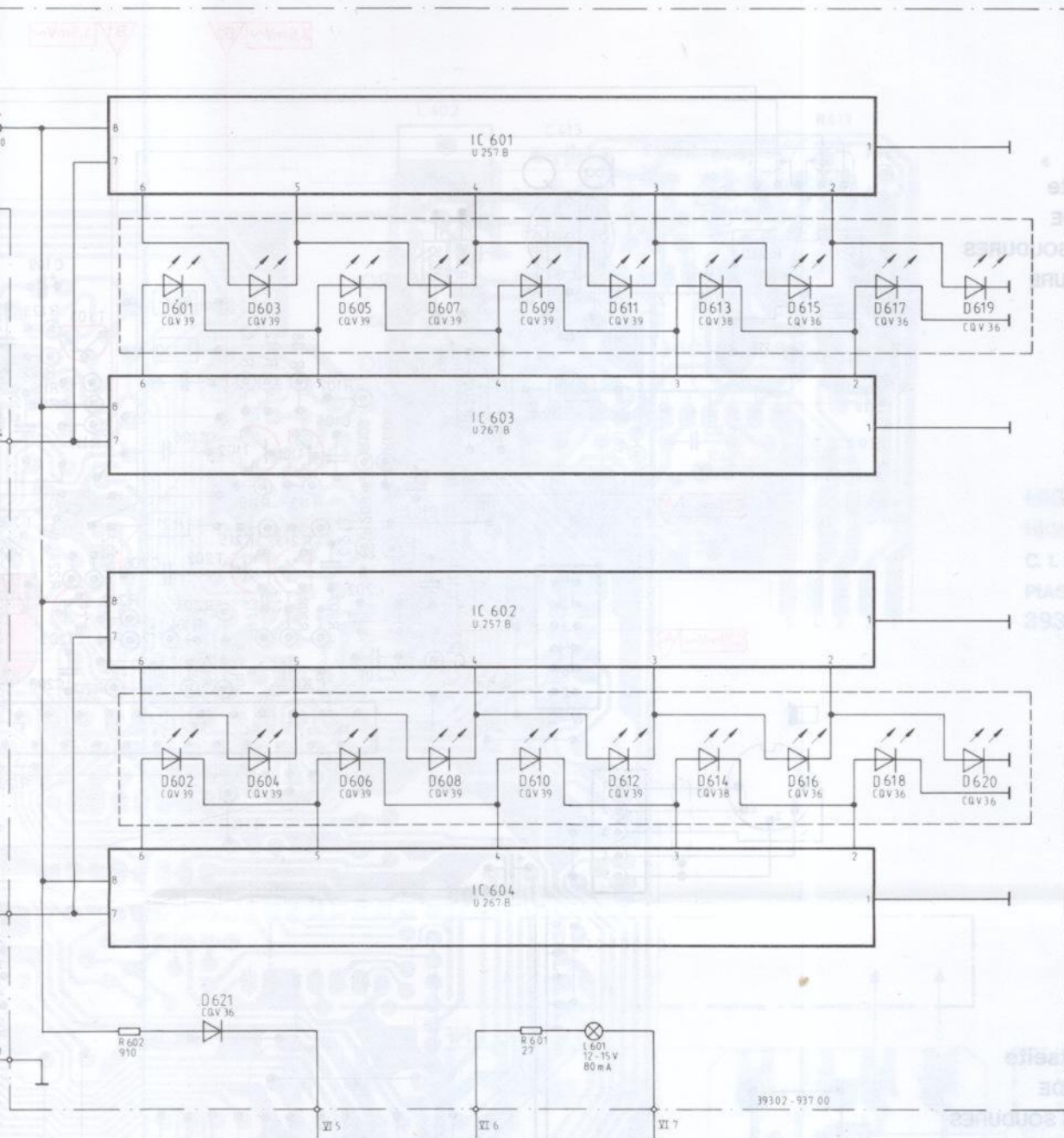

- R124 links } Wiedergabepiegel
PLAYBACK LEVEL
NIVEAU LECTURE
LIVELLO DI RIPRODUZIONE
- R224 rechts }
- R134 links } Bandempfindlichkeit
TAPE SENSITIVITY
SENSIBILITE DE BANDE
SENSIBILITA DEL NASTRO
- R234 rechts }
- C136 links } Vormagnetisierung
BIAS
PREMAGNETISATION
PREMAGNETIZZAZIONE
- C236 rechts }
- R116 links } Pegelregler
LEVEL CONTROL
REGAGE NIVEAU
REGOLATORE DI LIVELLO
- R216 rechts }
- R132 links } Ausgangspegel
OUTPUT LEVEL
NIVEAU SORTIE
LIVELLO DI USCITA
- R232 rechts }
- R300 } Löschkopfstrom
ERASE HEAD CURRENT
COURRANT D'EFFACEMENT
CORRENTE DI CANCELLAZIONE
- A } Aufnahme
RECORDING
ENREGISTREMENT
REGISTRAZIONE
- W } Wiedergabe
PLAYBACK
REPRODUCTION
ASCOLTO
- Fe } Bandsorten
TAPE TYPE
TYPE DE BANDE
SPECIE DI NASTRO
- Cr }
- Me }
- Mi } Mikrofon
MICROPHONE
MICRO
- Ro } Radio
- HICO } HIGH COM ein
HIGH COM ON
HIGH COM EN CIRCUIT
HIGH COM INSERITO
- HIC0 } HIGH COM aus
HIGH COM OFF
HIGH COM HORS CIRCUIT
HIGH COM DISINSERITO
- NR } NR - Expander ein
NR EXPANDER ON
EXPANSEUR NR EN CIRCUIT
NR - EXPANDER INSERITO
- NR0 } NR - Expander aus
NR EXPANDER OFF
EXPANSEUR NR HORS CIRCUIT
NR - EXPANDER DISINSERITO

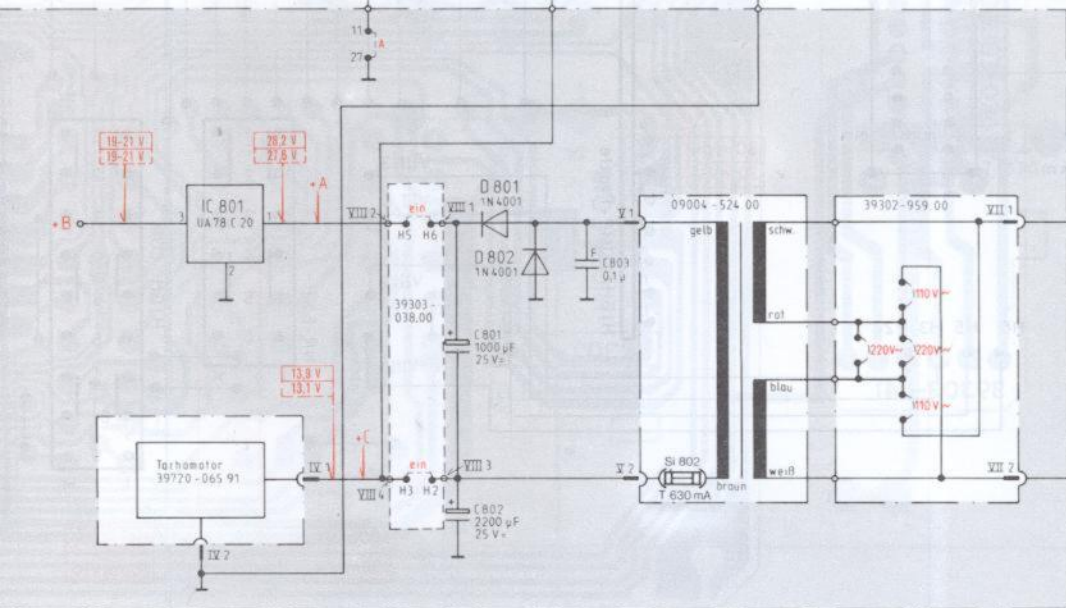

- Spannungen gemessen bei Netzbetrieb 220V ~ gegen Masse. Eingangswiderstand des Voltmeters Ri = 1 MΩ
- VOLTAGES MEASURED AGAINST EARTH AT 220V AC INPUT RESISTANCE OF VOLTMETER Ri = 1 MΩ
- TENSIONI MISURATE A UNA TENSIONE SECTEUR DE 220V ~ PAR RAPPORT A TERRE LA RESISTANCE D'ENTREE DU VOLTMETRE DOIT ETRE Ri = 1 MΩ
- TENSIONI MISURATE CON FUNZIONAMENTO A 220V ~ VERSO MASSA. RESISTENZA D'INGRESSO DEL VOLTMETRO Ri = 1 MΩ
- Netz MAINS SECTEUR
220V 50/60 Hz
110V 50/60 Hz
- Autnahme, FeCr Start
Wiedergabe, FeCr Start
f = 333 Hz * TOLERANCE ± 2dB
 - RECORDING, FeCr START
PLAYBACK, FeCr START
f = 333 Hz * TOLERANCE ± 2dB
 - ENREGISTREMENT, FeCr MARCHÉ
REPRODUCTION, FeCr MARCHÉ
f = 333 Hz * TOLERANCE ± 2dB
 - REGISTRAZIONE, FeCr START
ASCOLTO, FeCr START
f = 333 Hz * TOLERANCE ± 2dB

gez. in Stellung aus
SHOWN IN POS. OUT
MONTRE EN POS. ARRÊT
RAPPRE IN POS. SPENTO

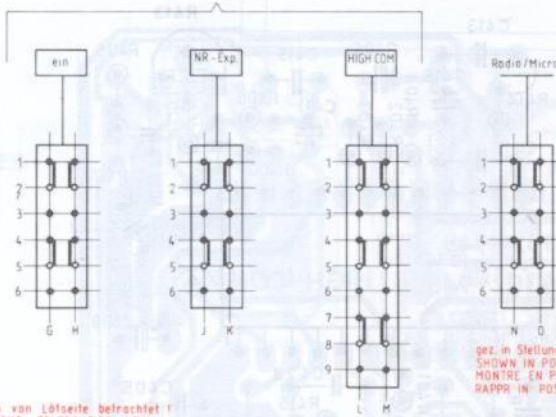
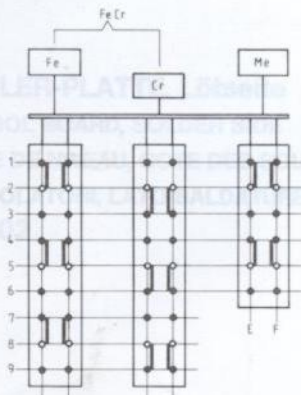

Drucktasten von Lötseite betrachten!
PUSH BUTTONS, SOLDER SIDE VIEW!
TOUCHES VUES DU CÔTÉ SOUDURES!
TASTI VISTI DAL LATO SALDATURA!

gez. in Stellung Radio
SHOWN IN POS. RADIO
MONTRE EN POS. RADIO
RAPPRE IN POS. RADIO

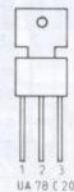
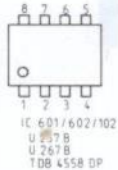

0207 DIN rauschärm

0207 DIN

0204 DIN nicht brennbar
NON INFIAMMABILE
NON INFIAMMABILE

0411 DIN rauschärm
LOW NOISE
A FAIBLE BRUIT
A FIEVOLE FRUSCIO

Elko

Tantal-Elko

Folien-Kond

Keramik-Kond

Styrolflex-Kond

TT Ferritperle
FERRITE BEAD
PERLE FERRITE
PERLA FERRITE



CGV 39 - grün
GREEN
VERT
VERDIL
CGV 38 - gelb
YELLOW
JAUNE
GIALLD
CGV 36 - rot
RED
ROUGE
ROSSO

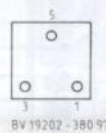
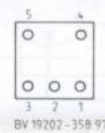
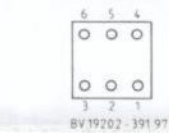

Anderungen vorbehalten!
ALTERATIONS RESERVED!
MODIFICATIONS RESERVEES!
CON RISERVA DI MODIFICA!

Kopfanschlüsse
HEAD CONNECTIONS
CONNEXIONS DE TÊTE
CONNESSIONI DELLA DESTINA

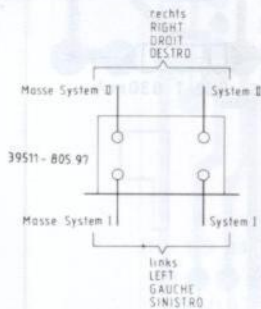

Schalterkontakt
SWITCH CONTACT
CONTACT DE COMMUTEUR
CONTATTO DI COMMUTATORE
Z.B. geschlossen bei Aufnahme
EG. CLOSED WHEN RECORDING
PEX - FERME EN ENREGISTREMENT
PER ES CHIUSO IN REGISTRAZIONE

Schiebeschalter
SLIDING SWITCH
COMMUTEUR DE MOUVEMENT
COMMUTATORE A CURSORE

| | |
|--|----------------|
| AW | 39706 - 238 00 |
| Start - Stop MARCHÉ - STOP | 39706 - 239 00 |
| Radio - Mikro | 39400 - 104 00 |
| HIGH-COM | 39400 - 103 07 |
| Netz ein/aus MAINS ON/OFF SECTEUR EN CIRCUIT/HORS CIRCUIT RETE INSERITO/DISINSERITO | 39400 - 101 07 |
| NR - Exp | 39400 - 101 07 |
| Bandwahl TAPE SELECTION SELECTION BANDES SELEZIONE NASTRI | 39400 - 102 07 |



Gekennzeichnete Bauteile: Aus Sicherheitsgründen nur durch Originalbauteile ersetzen!
MARKED COMPONENTS: FOR SAFETY REASONS, REPLACE THESE COMPONENTS BY ORIGINAL COMPONENTS ONLY!
COMPONENTS REPÉRÉS: POUR DES RAISONS DE SÛRETÉ, NE REMPLACET CES COMPONENTS PAR DES QUE COMPONENTS ORIGINAUX!
I COMPONENTI CONTRASSEGNA TI CON QUESTO SIMBOLO SONO DA SOSTITUIRE - PER MOTIVI DI SICUREZZA - SOLTANTO CON PEZZI DI RICAMBIO ORIGINALI!

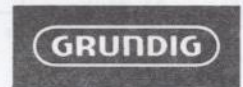

CF 5100
Direct-Frontloader

(32055-906.00)

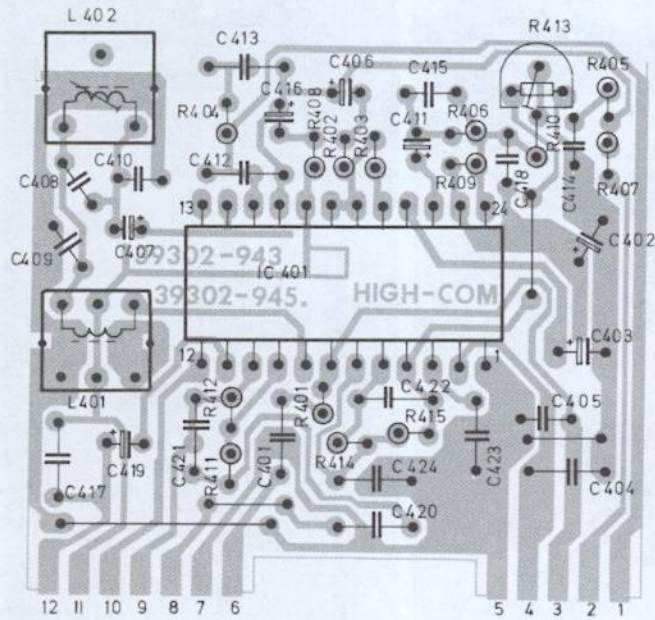

PEGELREGLER-
LEVEL CONTROL BO
C. I. RÉGLAGE DE N
PIASTRA REGOLATO
39302-931.02

HIGH-COM.-PLATTE, Lötseite
HIGH COM-BOARD, SOLDER SIDE
C. I. HIGH-COM., COTE DES SOUDURES
PIASTRA HIGH-COM., LATO SALDATURE
39302-942.00

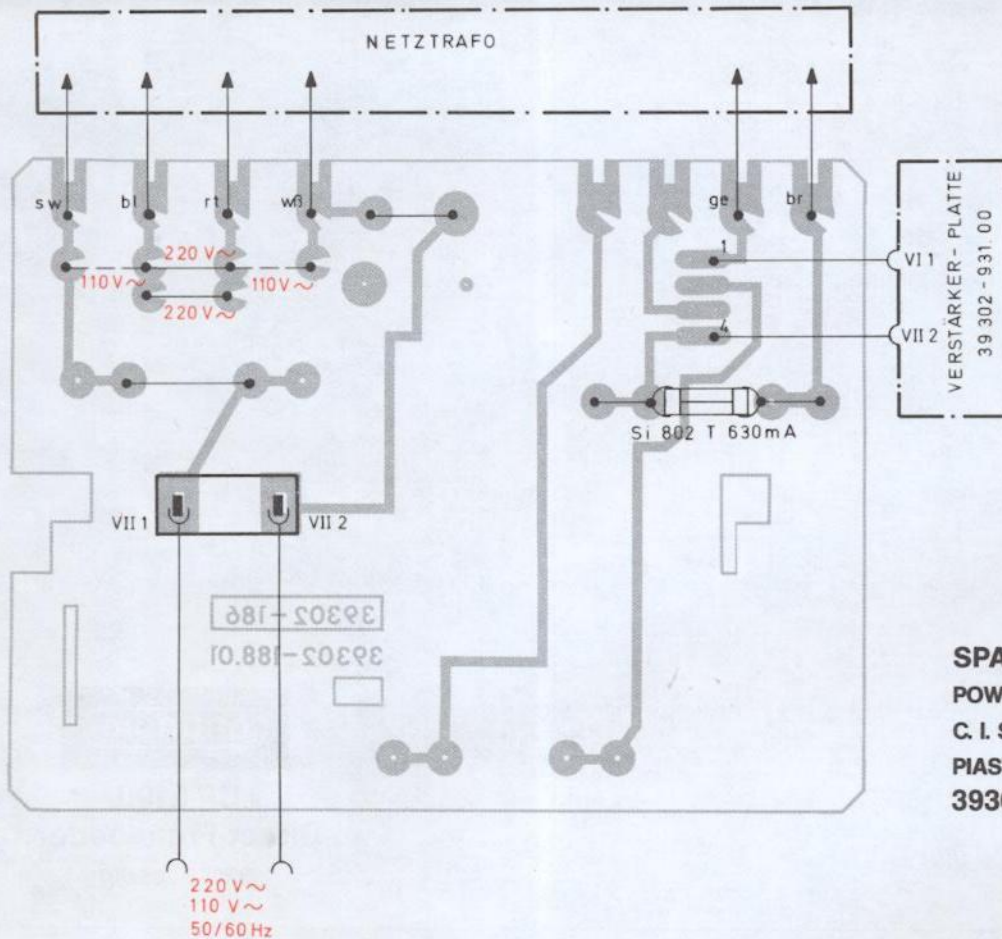

NETZSCHALT
MAINS SWITCH B
C. I. COMMUT. SE
PIASTRA INTERRU
39303-038.00

SPANNUNGS-PLATTE, Bestückungsseite
POWER SUPPLY BOARD, COMPONENT SIDE
C. I. SÉLECTEUR TENSION, VUE DU COTE DES COM
PIASTRA DI ALIMENT., LATO COMPONENTI
39302-959.00

GELREGLER-PLATTE, Lötseite
LEVEL CONTROL BOARD, SOLDER SIDE
RÉGLAGE DE NIVEAU, COTE DES SOUDURES
PIASTRA REGOLATORI, LATO SALDATURE
02-931.02

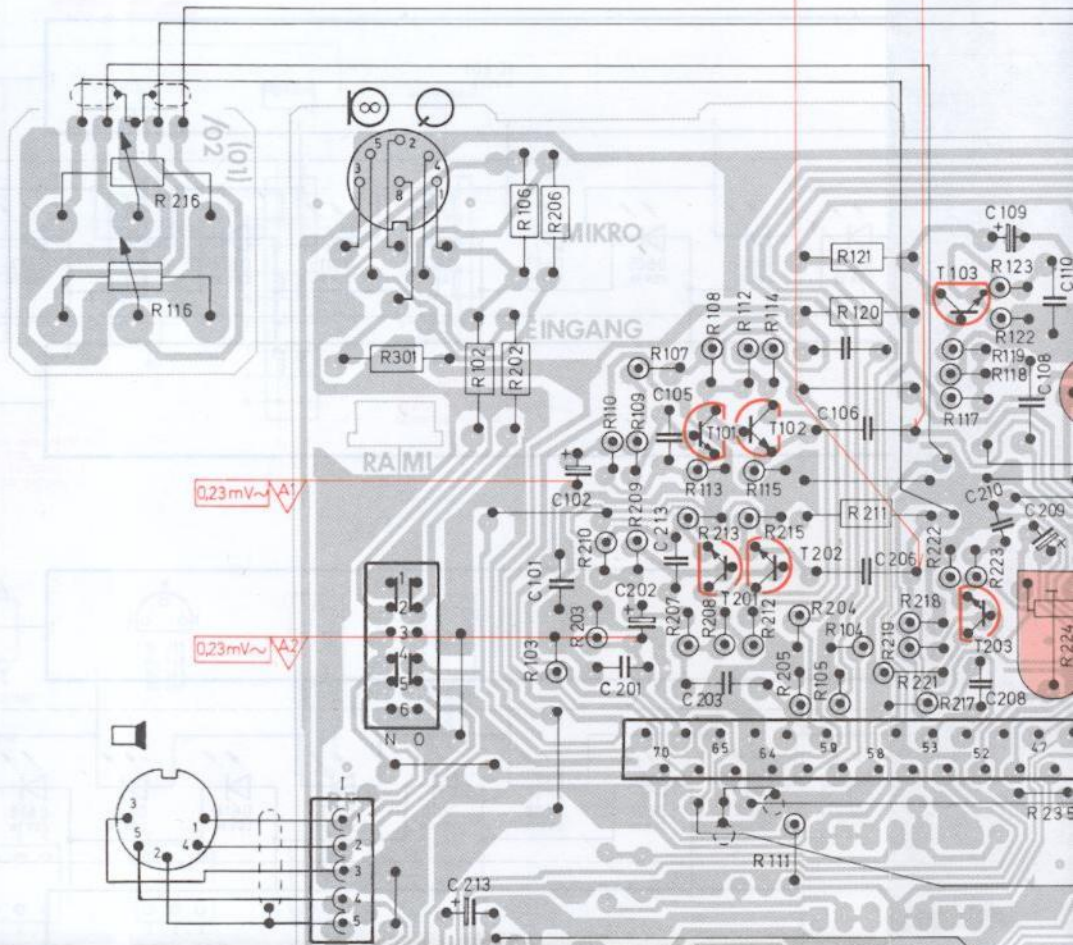

NETZSCHALTER-PLATTE, Lötseite
MAIN SWITCH BOARD, SOLDER SIDE
PL. I. COMMUT. SECTEUR, COTE DES SOUDURES
PIASTRA INTERRUOTTORE RETE, LATO SALDATURE
9303-038.00

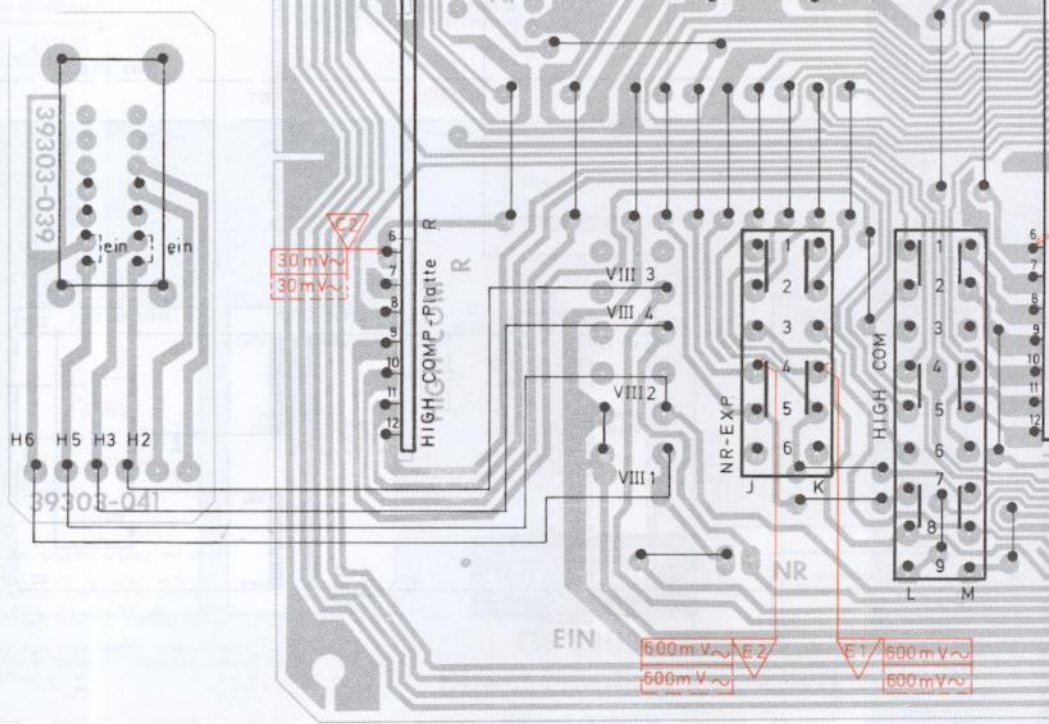

ückungsseite
NT SIDE
COTE DES COMPOSANTS
ONENTI

**VERSTÄRKER-
AMPLIFIER PCB, S
C. I. AMPLIFICATE
PIASTRA AMPLIFI
39302-931.00**

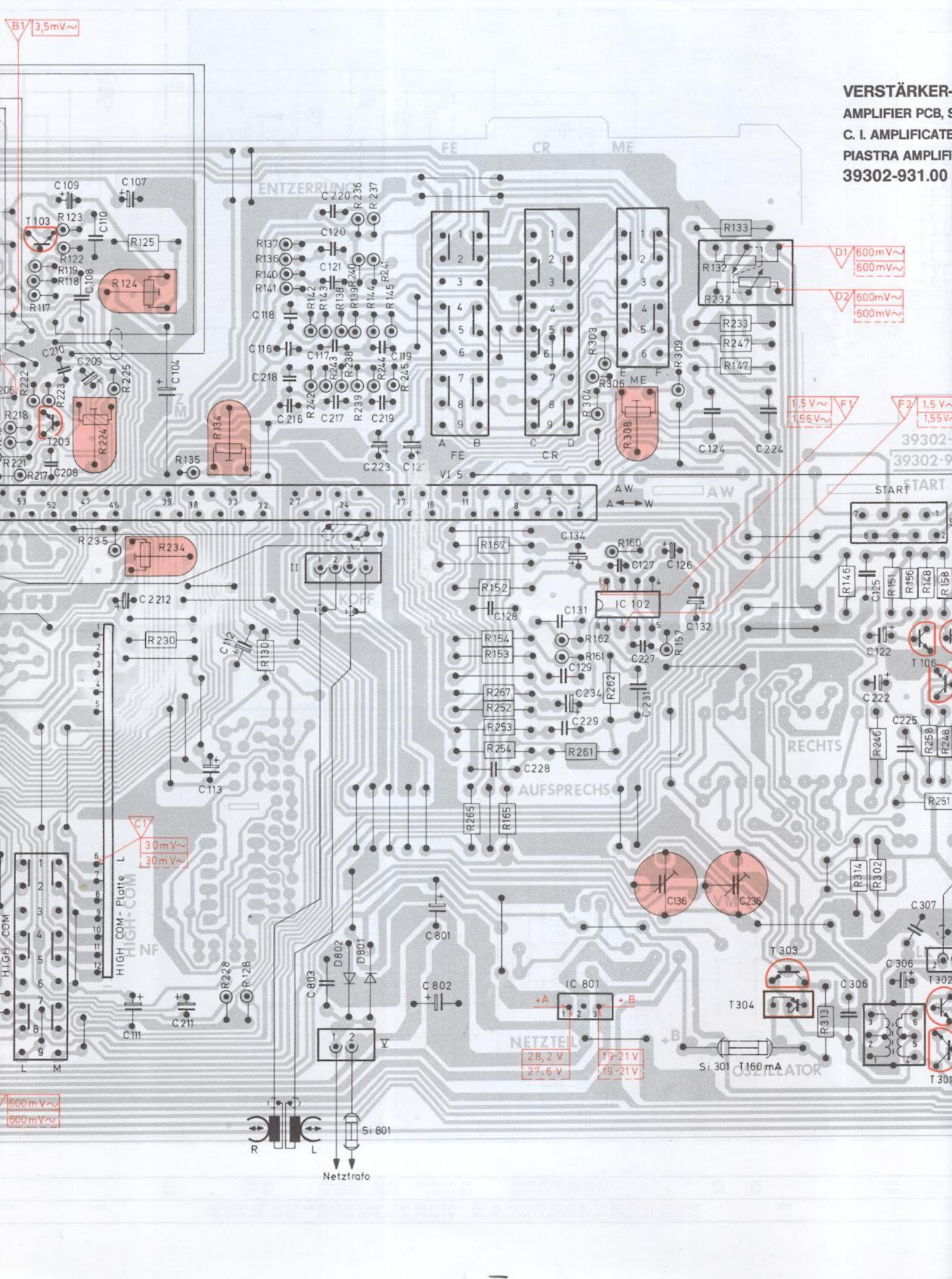

B1 3,5mV~

D1 600mV~

D2 600mV~

F1 1,5V~

F2 1,5V~

C1 30mV~

600mV~

28,2 V

27,6 V

19-21 V

19-21 V

39302-931.00

39302-931.00

39302-931.00

39302-931.00

39302-931.00

39302-931.00

39302-931.00

39302-931.00

39302-931.00

39302-931.00

39302-931.00

39302-931.00

39302-931.00

39302-931.00

39302-931.00

39302-931.00

39302-931.00

39302-931.00

39302-931.00

39302-931.00

39302-931.00

39302-931.00

39302-931.00

39302-931.00

39302-931.00

39302-931.00

39302-931.00

39302-931.00

39302-931.00

39302-931.00

39302-931.00

39302-931.00

39302-931.00

VERSTÄRKER-PLATTE, Lötseite

AMPLIFIER PCB, SOLDER SIDE

C. I. AMPLIFICATEUR, COTE DES SOUDURES

PIASTRA AMPLIFICAT., LATO SALDATURE

39302-931.00

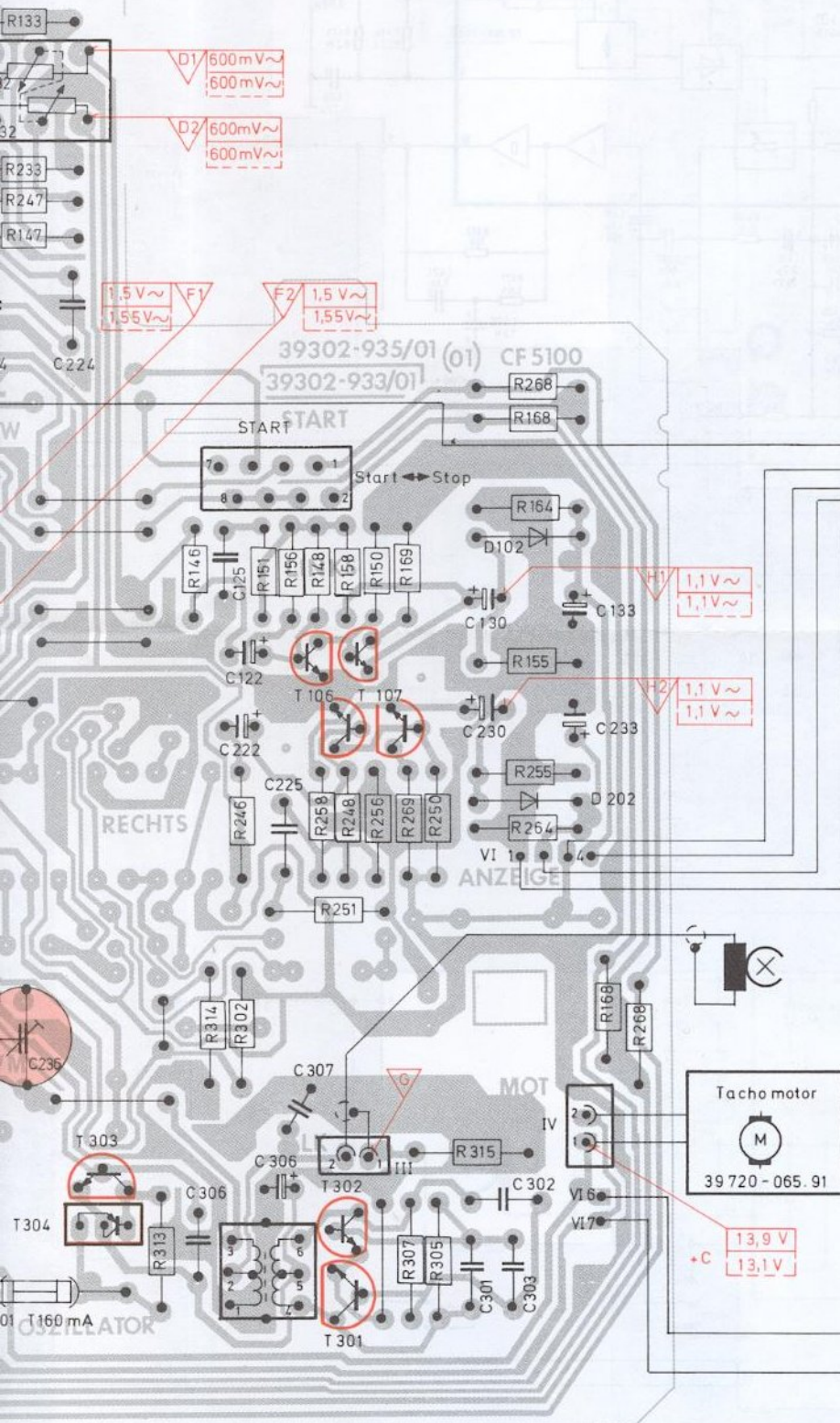

ANZEIGEPLATTE, Lötseite

INDICATION BOARD, SOLDER SIDE

C. I. AFFICHAGE, COTE DES SOUDURES

PIASTRA INDICAZIONE, LATO SALDATURE

39302-937.00

